

BEGRIPA

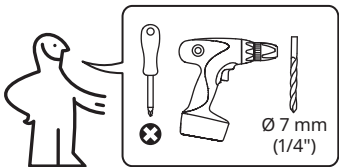

1

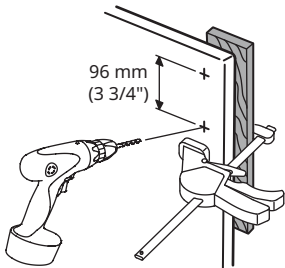

2

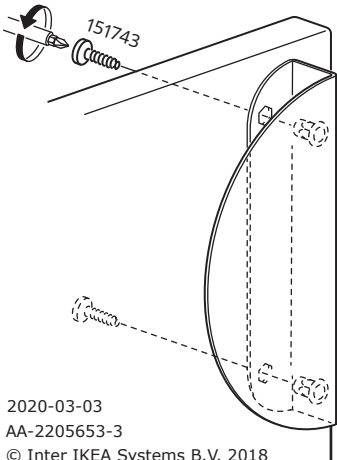

2020-03-03

AA-2205653-3

© Inter IKEA Systems B.V. 2018